

## PART - I : CHEMISTRY

## SECTION - I (Single Correct Choice Type)

This Section contains 8 multiple choice questions. Each question has four choices A), B), C) and D) out of which ONLY ONE is correct.

1. The correct structure of ethylenediaminetetraacetic acid (EDTA) is

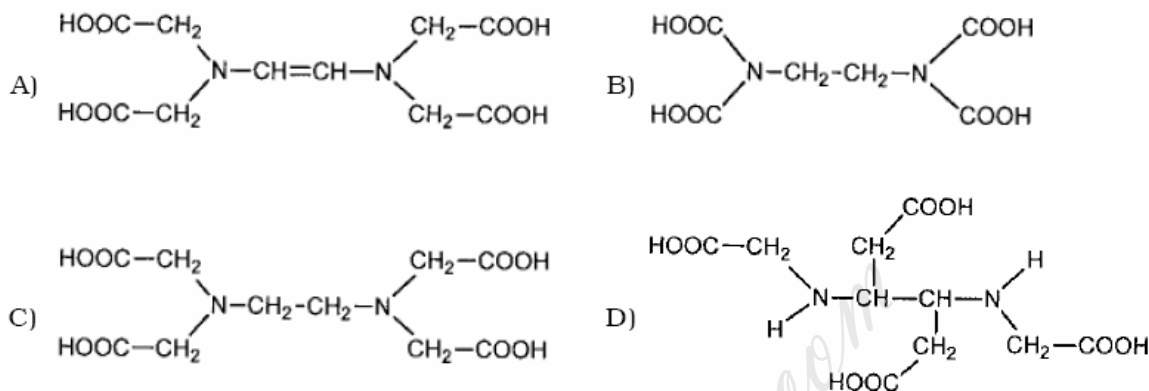

ANSWER: C

2. The ionization isomer of  $[\text{Cr}(\text{H}_2\text{O})_4\text{Cl}(\text{NO}_2)]\text{Cl}$  is

- A)  $[\text{Cr}(\text{H}_2\text{O})_4(\text{O}_2\text{N})]\text{Cl}_2$   
 B)  $[\text{Cr}(\text{H}_2\text{O})_4\text{Cl}_2](\text{NO}_2)$   
 C)  $[\text{Cr}(\text{H}_2\text{O})_4\text{Cl}(\text{ONO})]\text{Cl}$   
 D)  $[\text{Cr}(\text{H}_2\text{O})_4\text{Cl}_2(\text{NO}_2)] \cdot \text{H}_2\text{O}$

ANSWER: B

3. The synthesis of 3-octyne is achieved by adding a bromoalkane into a mixture of sodium amide and an alkyne. The bromoalkane and alkyne respectively are

- A)  $\text{BrCH}_2\text{CH}_2\text{CH}_2\text{CH}_2\text{CH}_3$  and  $\text{CH}_3\text{CH}_2\text{C}\equiv\text{CH}$   
 B)  $\text{BrCH}_2\text{CH}_2\text{CH}_3$  and  $\text{CH}_3\text{CH}_2\text{CH}_2\text{C}\equiv\text{CH}$   
 C)  $\text{BrCH}_2\text{CH}_2\text{CH}_2\text{CH}_2\text{CH}_3$  and  $\text{CH}_3\text{C}\equiv\text{CH}$   
 D)  $\text{BrCH}_2\text{CH}_2\text{CH}_2\text{CH}_3$  and  $\text{CH}_3\text{CH}_2\text{C}\equiv\text{CH}$

ANSWER: D

4. The correct statement about the following disaccharide is

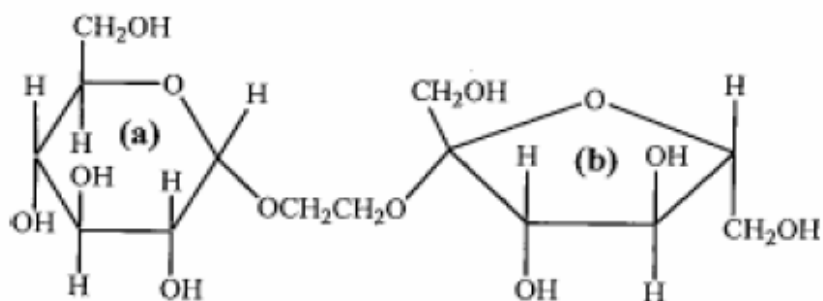

- A) Ring (a) is pyranose with  $\alpha$ -glycosidic link
- B) Ring (a) is furanose with  $\alpha$ -glycosidic link
- C) Ring (b) is furanose with  $\alpha$ -glycosidic link
- D) Ring (b) is pyranose with  $\beta$ -glycosidic link

**ANSWER: A**

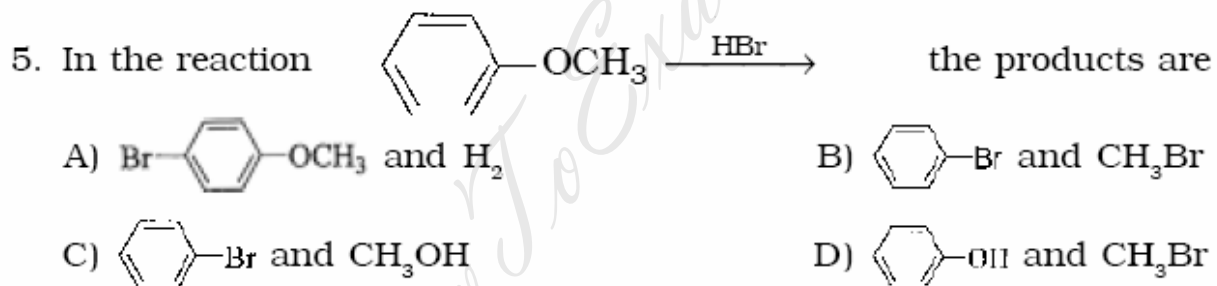

**ANSWER: D**

6. Plots showing the variation of the rate constant ( $k$ ) with temperature ( $T$ ) are given below. The plot that follows Arrhenius equation is

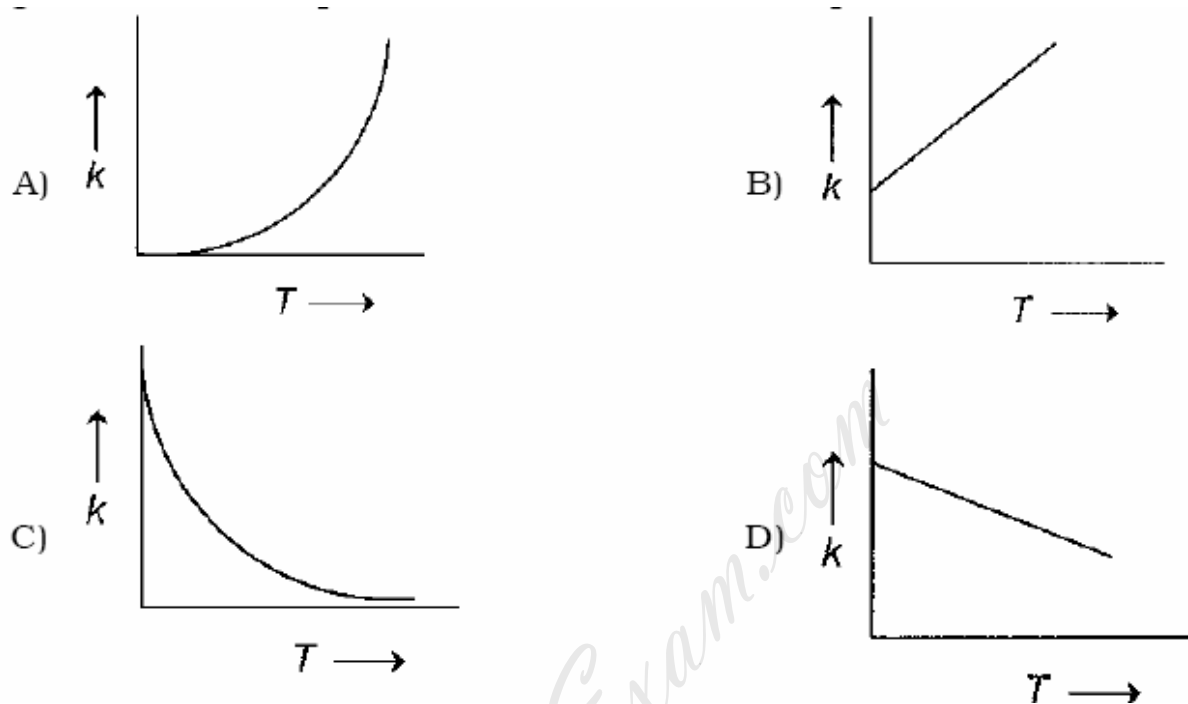

**ANSWER: A**

7. The species which by definition has **ZERO** standard molar enthalpy of formation at 298 K is

- A)  $\text{Br}_2$  (g)                      B)  $\text{Cl}_2$  (g)                      C)  $\text{H}_2\text{O}$  (g)                      D)  $\text{CH}_4$  (g)

**ANSWER: B**

8. The bond energy (in  $\text{kcal mol}^{-1}$ ) of a C-C single bond is approximately

- A) 1                                      B) 10                                      C) 100                                      D) 1000

**ANSWER: C**

**SECTION - II (Multiple Correct Choice Type)**

9. The reagent(s) used for softening the temporary hardness of water is(are)  
A)  $\text{Ca}_3(\text{PO}_4)_2$       B)  $\text{Ca}(\text{OH})_2$       C)  $\text{Na}_2\text{CO}_3$       D)  $\text{NaOCl}$

**ANSWER: B**

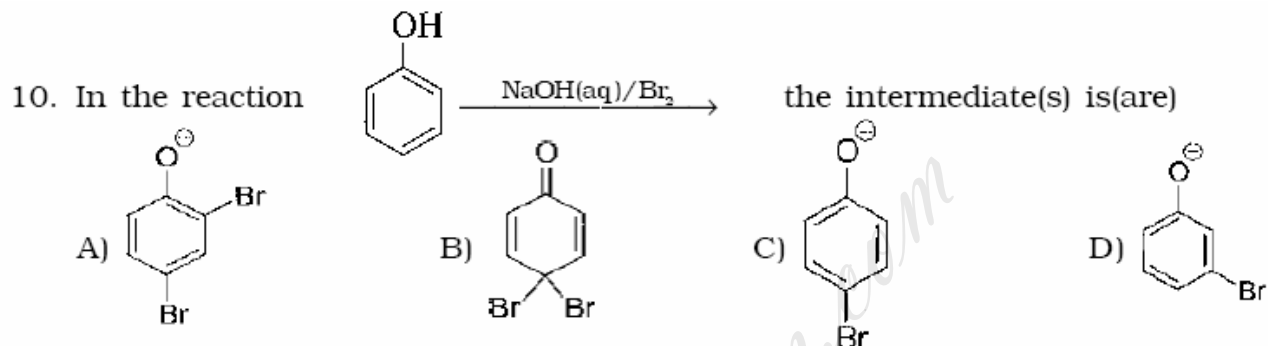

**ANSWER: A and C**

11. In the Newman projection for 2,2-dimethylbutane

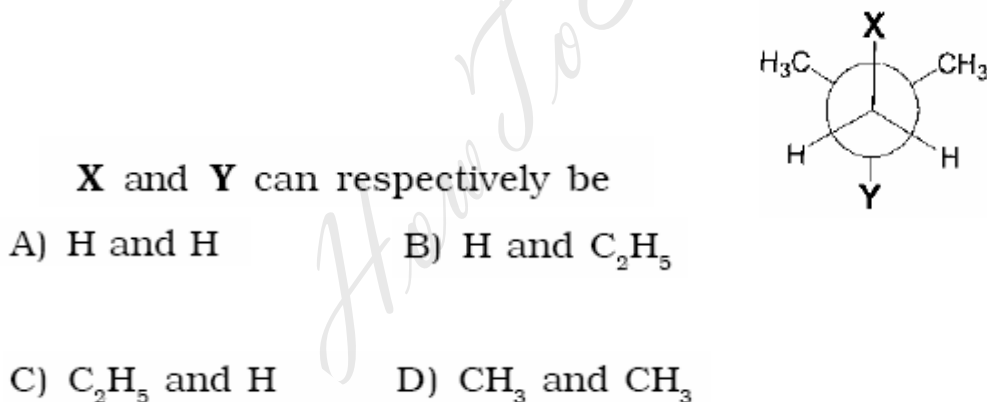

**ANSWER: B and D**

12. Among the following, the intensive property is (properties are)
- A) molar conductivity      B) electromotive force  
C) resistance      D) heat capacity

**ANSWER: A and B**

13. Aqueous solutions of  $\text{HNO}_3$ ,  $\text{KOH}$ ,  $\text{CH}_3\text{COOH}$ , and  $\text{CH}_3\text{COONa}$  of identical concentrations are provided. The pair(s) of solutions which form a buffer upon mixing is(are)

- A)  $\text{HNO}_3$  and  $\text{CH}_3\text{COOH}$                       B)  $\text{KOH}$  and  $\text{CH}_3\text{COONa}$   
C)  $\text{HNO}_3$  and  $\text{CH}_3\text{COONa}$                       D)  $\text{CH}_3\text{COOH}$  and  $\text{CH}_3\text{COONa}$

**ANSWER: C and D**

**SECTION - III (Paragraph Type)**

**Paragraph for Questions 14 to 16**

Copper is the most noble of the first row transition metals and occurs in small deposits in several countries. Ores of copper include chalcocite ( $\text{Cu}_2\text{O}$ ), atacamite ( $\text{Cu}_2\text{Cl}(\text{OH})_3$ ), cuprite ( $\text{Cu}_2\text{O}$ ), copper glance ( $\text{Cu}_2\text{S}$ ) and malachite ( $\text{Cu}_2(\text{OH})_2\text{CO}_3$ ). However, 80% of the world copper production comes from the ore chalcopyrite ( $\text{CuFeS}_2$ ). The extraction of copper from chalcopyrite involves partial roasting, removal of iron and self-reduction.

14. Partial roasting of chalcopyrite produces

- A)  $\text{Cu}_2\text{S}$  and  $\text{FeO}$   
B)  $\text{Cu}_2\text{O}$  and  $\text{FeO}$   
C)  $\text{CuS}$  and  $\text{Fe}_2\text{O}_3$   
D)  $\text{Cu}_2\text{O}$  and  $\text{Fe}_2\text{O}_3$

**ANSWER: A**

15. Iron is removed from chalcopyrite as

- A)  $\text{FeO}$                       B)  $\text{FeS}$   
C)  $\text{Fe}_2\text{O}_3$                       D)  $\text{FeSiO}_3$

**ANSWER: D**

16. In self-reduction, the reducing species is

- A) S            B)  $O^{2-}$   
C)  $S^{2-}$         D)  $SO_2$

**ANSWER: C**

**Paragraph for Questions 17 to 18**

The concentration of potassium ions inside a biological cell is at least twenty times higher than the outside. The resulting potential difference across the cell is important in several processes such as transmission of nerve impulses and maintaining the ion balance. A simple model for such a concentration cell involving a metal M is:

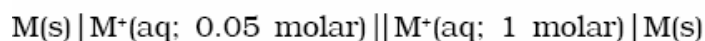

For the above electrolytic cell the magnitude of the cell potential  $|E_{\text{cell}}| = 70 \text{ mV}$ .

17. For the above cell

- A)  $E_{\text{cell}} < 0$ ;  $\Delta G > 0$     B)  $E_{\text{cell}} > 0$ ;  $\Delta G < 0$   
C)  $E_{\text{cell}} < 0$ ;  $\Delta G^0 > 0$     D)  $E_{\text{cell}} > 0$ ;  $\Delta G^0 < 0$

**ANSWER: B**

18. If the 0.05 molar solution of  $M^+$  is replaced by a 0.0025 molar  $M^+$  solution, then the magnitude of the cell potential would be

- A) 35 mV            B) 70 mV  
C) 140 mV         D) 700 mV

**ANSWER: C**

**SECTION - IV (Integer Type)**

19. The total number of basic groups in the following form of lysine is

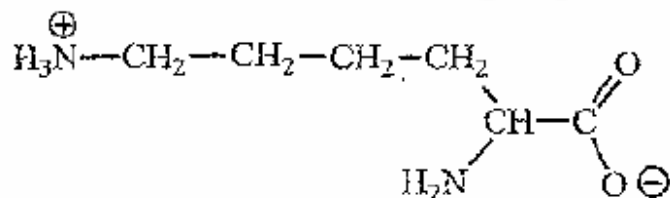

**ANSWER: 2**

20. The total number of cyclic isomers possible for a hydrocarbon with the molecular formula  $\text{C}_4\text{H}_6$  is

**ANSWER: 5**

21. In the reaction sequence shown below, the product **Y** is formed by the reaction of the starting material with  $\text{O}_3$  followed by  $\text{Zn, H}_2\text{O}$ . The starting material is 1,2-dihydronaphthalene. The reaction of **Y** with  $\text{NaOH(aq)}$  followed by heat is a molecular aldol condensation.

**ANSWER: 1**

22. Amongst the following, the total number of compounds soluble in aqueous  $\text{NaOH}$  is

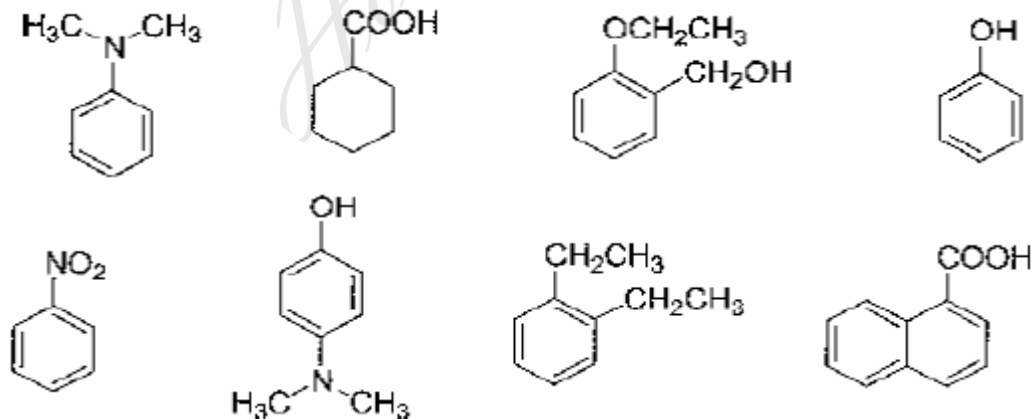

**ANSWER: 4**

23. Amongst the following, the total number of compounds whose aqueous solution turns red litmus paper blue is

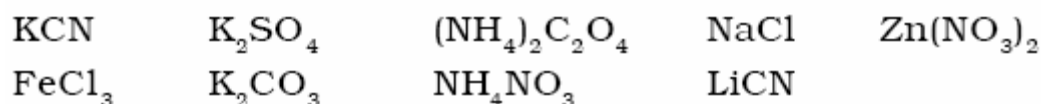

**ANSWER: 3**

24. Based on VSEPR theory, the number of 90 degree F-Br-F angles in  $BrF_5$  is

**ANSWER: either 0 or 8**

25. The value of n in the molecular formula  $Be_nAl_2Si_6O_{18}$  is

**ANSWER: 3**

26. A student performs a titration with different burettes and finds titre values of 25.2 mL, 25.25 mL, and 25.0 mL. The number of significant figures in the average titre value is

**ANSWER: 3**

27. The concentration of R in the reaction  $R \rightarrow P$  was measured as a function of time and the following data is obtained:

[R] (molar)	1.0	0.75	0.40	0.10
t(min.)	0.0	0.05	0.12	0.18

The order of the reaction is

**ANSWER: 0**

28. The number of neutrons emitted when  ${}_{92}^{235}U$  undergoes controlled nuclear fission to  ${}_{54}^{142}Xe$  and  ${}_{38}^{90}Sr$  is

**ANSWER: 4**



**PART – II : MATHEMATICS**

**SECTION – I (Single Correct Choice Type)**

29. If the angles A, B and C of a triangle are in an arithmetic progression and if a, b and c denote the lengths of the sides opposite to A, B and C respectively, then

the value of the expression  $\frac{a}{c}\sin 2C + \frac{c}{a}\sin 2A$  is

- A)  $\frac{1}{2}$                       B)  $\frac{\sqrt{3}}{2}$                       C) 1                      D)  $\sqrt{3}$

**ANSWER: D**

30. Equation of the plane containing the straight line  $\frac{x}{2} = \frac{y}{3} = \frac{z}{4}$  and perpendicular to

the plane containing the straight lines  $\frac{x}{3} = \frac{y}{4} = \frac{z}{2}$  and  $\frac{x}{4} = \frac{y}{2} = \frac{z}{3}$  is

- A)  $x + 2y - 2z = 0$     B)  $3x + 2y - 2z = 0$     C)  $x - 2y + z = 0$     D)  $5x + 2y - 4z = 0$

**ANSWER: C**

31. Let  $\omega$  be a complex cube root of unity with  $\omega \neq 1$ . A fair die is thrown three times. If  $r_1, r_2$  and  $r_3$  are the numbers obtained on the die, then the probability that

$\omega^{r_1} + \omega^{r_2} + \omega^{r_3} = 0$  is

- A)  $\frac{1}{18}$                       B)  $\frac{1}{9}$                       C)  $\frac{2}{9}$                       D)  $\frac{1}{36}$

**ANSWER: C**

32. Let P, Q, R and S be the points on the plane with position vectors  $-2\hat{i} - \hat{j}$ ,  $4\hat{i}$ ,  $3\hat{i} + 3\hat{j}$  and  $-3\hat{i} + 2\hat{j}$  respectively. The quadrilateral PQRS must be a

- A) parallelogram, which is neither a rhombus nor a rectangle  
 B) square  
 C) rectangle, but not a square  
 D) rhombus, but not a square

**ANSWER: A**

33. The number of  $3 \times 3$  matrices  $A$  whose entries are either 0 or 1 and for which the system

$$A \begin{bmatrix} x \\ y \\ z \end{bmatrix} = \begin{bmatrix} 1 \\ 0 \\ 0 \end{bmatrix} \text{ has exactly two distinct solutions, is}$$

- A) 0                                      B)  $2^9 - 1$                                       C) 168                                      D) 2

**ANSWER: A**

34. The value of  $\lim_{x \rightarrow 0} \frac{1}{x^3} \int_0^x \frac{t \ln(1+t)}{t^4+4} dt$  is

- A) 0                                      B)  $\frac{1}{12}$                                       C)  $\frac{1}{24}$                                       D)  $\frac{1}{64}$

**ANSWER: B**

35. Let  $p$  and  $q$  be real numbers such that  $p \neq 0$ ,  $p^3 \neq q$  and  $p^3 \neq -q$ . If  $\alpha$  and  $\beta$  are nonzero complex numbers satisfying  $\alpha + \beta = -p$  and  $\alpha^3 + \beta^3 = q$ , then a quadratic equation having  $\frac{\alpha}{\beta}$  and  $\frac{\beta}{\alpha}$  as its roots is

- A)  $(p^3 + q)x^2 - (p^3 + 2q)x + (p^3 + q) = 0$     B)  $(p^3 + q)x^2 - (p^3 - 2q)x + (p^3 + q) = 0$   
C)  $(p^3 - q)x^2 - (5p^3 - 2q)x + (p^3 - q) = 0$     D)  $(p^3 - q)x^2 - (5p^3 + 2q)x + (p^3 - q) = 0$

**ANSWER: B**

36. Let  $f$ ,  $g$  and  $h$  be real-valued functions defined on the interval  $[0, 1]$  by  $f(x) = e^{x^2} + e^{-x^2}$ ,  $g(x) = xe^{x^2} + e^{-x^2}$  and  $h(x) = x^2e^{x^2} + e^{-x^2}$ . If  $a$ ,  $b$  and  $c$  denote, respectively, the absolute maximum of  $f$ ,  $g$  and  $h$  on  $[0, 1]$ , then

- A)  $a = b$  and  $c \neq b$     B)  $a = c$  and  $a \neq b$   
C)  $a \neq b$  and  $c \neq b$     D)  $a = b = c$

**ANSWER: D**

**SECTION - II (Multiple Correct Choice Type)**

37. Let A and B be two distinct points on the parabola  $y^2 = 4x$ . If the axis of the parabola touches a circle of radius  $r$  having AB as its diameter, then the slope of the line joining A and B can be

- A)  $-\frac{1}{r}$                       B)  $\frac{1}{r}$                       C)  $\frac{2}{r}$                       D)  $-\frac{2}{r}$

**ANSWER: C and D**

38. Let ABC be a triangle such that  $\angle ACB = \frac{\pi}{6}$  and let a, b and c denote the lengths of the sides opposite to A, B and C respectively. The value(s) of x for which  $a = x^2 + x + 1$ ,  $b = x^2 - 1$  and  $c = 2x + 1$  is (are)

- A)  $-(2 + \sqrt{3})$                       B)  $1 + \sqrt{3}$                       C)  $2 + \sqrt{3}$                       D)  $4\sqrt{3}$

**ANSWER: B**

39. Let  $z_1$  and  $z_2$  be two distinct complex numbers and let  $z = (1 - t)z_1 + tz_2$  for some real number  $t$  with  $0 < t < 1$ . If  $\text{Arg}(w)$  denotes the principal argument of a nonzero complex number  $w$ , then

- A)  $|z - z_1| + |z - z_2| = |z_1 - z_2|$                       B)  $\text{Arg}(z - z_1) = \text{Arg}(z - z_2)$   
C)  $\begin{vmatrix} z - z_1 & \bar{z} - \bar{z}_1 \\ z_2 - z_1 & \bar{z}_2 - \bar{z}_1 \end{vmatrix} = 0$                       D)  $\text{Arg}(z - z_1) = \text{Arg}(z_2 - z_1)$

**ANSWER: A and C and D**

40. Let  $f$  be a real-valued function defined on the interval  $(0, \infty)$  by

$$f(x) = \ln x + \int_0^x \sqrt{1+\sin t} \, dt. \text{ Then which of the following statement(s) is (are) true ?}$$

- A)  $f''(x)$  exists for all  $x \in (0, \infty)$
- B)  $f'(x)$  exists for all  $x \in (0, \infty)$  and  $f'$  is continuous on  $(0, \infty)$ , but not differentiable on  $(0, \infty)$
- C) there exists  $\alpha > 1$  such that  $|f'(x)| < |f(x)|$  for all  $x \in (\alpha, \infty)$
- D) there exists  $\beta > 0$  such that  $|f(x)| + |f'(x)| \leq \beta$  for all  $x \in (0, \infty)$

**ANSWER: B and C**

41. The value(s) of  $\int_0^1 \frac{x^4(1-x)^4}{1+x^2} dx$  is (are)

- A)  $\frac{22}{7} - \pi$
- B)  $\frac{2}{105}$
- C) 0
- D)  $\frac{71}{15} - \frac{3\pi}{2}$

**ANSWER: A**

**SECTION - III (Paragraph Type)**

**Paragraph for Questions 42 to 44**

Let  $p$  be an odd prime number and  $T_p$  be the following set of  $2 \times 2$  matrices :

$$T_p = \left\{ A = \begin{bmatrix} a & b \\ c & a \end{bmatrix} : a, b, c \in \{0, 1, 2, \dots, p-1\} \right\}$$

42. The number of  $A$  in  $T_p$  such that  $A$  is either symmetric or skew-symmetric or both, and  $\det(A)$  divisible by  $p$  is
- A)  $(p - 1)^2$
  - B)  $2(p - 1)$
  - C)  $(p - 1)^2 + 1$
  - D)  $2p - 1$

**ANSWER: D**

43. The number of  $A$  in  $T_p$  such that the trace of  $A$  is not divisible by  $p$  but  $\det(A)$  is divisible by  $p$  is

[Note : The trace of a matrix is the sum of its diagonal entries.]

- A)  $(p - 1)(p^2 - p + 1)$
- B)  $p^3 - (p - 1)^2$
- C)  $(p - 1)^2$
- D)  $(p - 1)(p^2 - 2)$

**ANSWER: C**

44. The number of  $A$  in  $T_p$  such that  $\det(A)$  is not divisible by  $p$  is

A)  $2p^2$

B)  $p^3 - 5p$

C)  $p^3 - 3p$

D)  $p^3 - p^2$

**ANSWER: D**

**Paragraph for Questions 45 to 46**

The circle  $x^2 + y^2 - 8x = 0$  and hyperbola  $\frac{x^2}{9} - \frac{y^2}{4} = 1$  intersect at the points  $A$  and  $B$ .

45. Equation of a common tangent with positive slope to the circle as well as to the hyperbola is

A)  $2x - \sqrt{5}y - 20 = 0$     B)  $2x - \sqrt{5}y + 4 = 0$

C)  $3x - 4y + 8 = 0$     D)  $4x - 3y + 4 = 0$

**ANSWER: B**

46. Equation of the circle with  $AB$  as its diameter is

A)  $x^2 + y^2 - 12x + 24 = 0$

B)  $x^2 + y^2 + 12x + 24 = 0$

C)  $x^2 + y^2 + 24x - 12 = 0$

D)  $x^2 + y^2 - 24x - 12 = 0$

**ANSWER: A**

**SECTION - IV (Integer Type)**

47. The number of values of  $\theta$  in the interval  $\left(-\frac{\pi}{2}, \frac{\pi}{2}\right)$  such that  $\theta \neq \frac{n\pi}{5}$  for  $n = 0, \pm 1, \pm 2$  and  $\tan \theta = \cot 5\theta$  as well as  $\sin 2\theta = \cos 4\theta$  is

**ANSWER: 3**

48. The maximum value of the expression  $\frac{1}{\sin^2 \theta + 3 \sin \theta \cos \theta + 5 \cos^2 \theta}$  is

**ANSWER: 2**

49. If  $\vec{a}$  and  $\vec{b}$  are vectors in space given by  $\vec{a} = \frac{\hat{i} - 2\hat{j}}{\sqrt{5}}$  and  $\vec{b} = \frac{2\hat{i} + \hat{j} + 3\hat{k}}{\sqrt{14}}$ , then the

value of  $\left( 2\vec{a} + \vec{b} \right) \cdot \left[ \left( \vec{a} \times \vec{b} \right) \times \left( \vec{a} - 2\vec{b} \right) \right]$  is

**ANSWER: 5**

50. The line  $2x + y = 1$  is tangent to the hyperbola  $\frac{x^2}{a^2} - \frac{y^2}{b^2} = 1$ . If this line passes through the point of intersection of the nearest directrix and the x-axis, then the eccentricity of the hyperbola is

**ANSWER: 2**

51. If the distance between the plane  $Ax - 2y + z = d$  and the plane containing the lines

$$\frac{x-1}{2} = \frac{y-2}{3} = \frac{z-3}{4} \text{ and } \frac{x-2}{3} = \frac{y-3}{4} = \frac{z-4}{5} \text{ is } \sqrt{6}, \text{ then } |d| \text{ is}$$

**ANSWER: 6**

52. For any real number  $x$ , let  $[x]$  denote the largest integer less than or equal to  $x$ . Let  $f$  be a real valued function defined on the interval  $[-10, 10]$  by

$$f(x) = \begin{cases} x - [x] & \text{if } [x] \text{ is odd,} \\ 1 + [x] - x & \text{if } [x] \text{ is even} \end{cases}$$

Then the value of  $\frac{\pi^2}{10} \int_{-10}^{10} f(x) \cos \pi x \, dx$  is

**ANSWER: 4**

53. Let  $\omega$  be the complex number  $\cos \frac{2\pi}{3} + i \sin \frac{2\pi}{3}$ . Then the number of distinct

complex numbers  $z$  satisfying  $\begin{vmatrix} z+1 & \omega & \omega^2 \\ \omega & z+\omega^2 & 1 \\ \omega^2 & 1 & z+\omega \end{vmatrix} = 0$  is equal to

**ANSWER: 1**

54. Let  $S_k$ ,  $k = 1, 2, \dots, 100$ , denote the sum of the infinite geometric series whose first term is  $\frac{k-1}{k!}$  and the common ratio is  $\frac{1}{k}$ . Then the value of  $\frac{100^2}{100!} + \sum_{k=1}^{100} \left| (k^2 - 3k + 1) S_k \right|$  is

**ANSWER: 3**

55. The number of all possible values of  $\theta$ , where  $0 < \theta < \pi$ , for which the system of equations

$$(y + z) \cos 3\theta = (xyz) \sin 3\theta$$

$$x \sin 3\theta = \frac{2 \cos 3\theta}{y} + \frac{2 \sin 3\theta}{z}$$

$$(xyz) \sin 3\theta = (y + 2z) \cos 3\theta + y \sin 3\theta$$

have a solution  $(x_0, y_0, z_0)$  with  $y_0 z_0 \neq 0$ , is

**ANSWER: 3**

56. Let  $f$  be a real-valued differentiable function on  $\mathbf{R}$  (the set of all real numbers) such that  $f(1) = 1$ . If the  $y$ -intercept of the tangent at any point  $P(x, y)$  on the curve  $y = f(x)$  is equal to the cube of the abscissa of  $P$ , then the value of  $f(-3)$  is equal to

**ANSWER: 9**

**PART – III : PHYSICS**

**SECTION – I (Single Correct Choice Type)**

57. Consider a thin square sheet of side  $L$  and thickness  $t$ , made of a material of resistivity  $\rho$ . The resistance between two opposite faces, shown by the shaded areas in the figure is

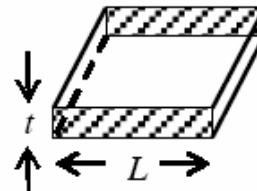

- A) directly proportional to  $L$
- B) directly proportional to  $t$
- C) independent of  $L$
- D) independent of  $t$

**ANSWER: C**

58. A real gas behaves like an ideal gas if its

- A) pressure and temperature are both high
- B) pressure and temperature are both low
- C) pressure is high and temperature is low
- D) pressure is low and temperature is high

**ANSWER: D**

59. Incandescent bulbs are designed by keeping in mind that the resistance of their filament increases with the increase in temperature. If at room temperature, 100 W, 60 W and 40 W bulbs have filament resistances  $R_{100}$ ,  $R_{60}$  and  $R_{40}$ , respectively, the relation between these resistances is

A)  $\frac{1}{R_{100}} = \frac{1}{R_{40}} + \frac{1}{R_{60}}$

B)  $R_{100} = R_{40} + R_{60}$

C)  $R_{100} > R_{60} > R_{40}$

D)  $\frac{1}{R_{100}} > \frac{1}{R_{60}} > \frac{1}{R_{40}}$

**ANSWER: D**



60. To verify Ohm's law, a student is provided with a test resistor  $R_T$ , a high resistance  $R_1$ , a small resistance  $R_2$ , two identical galvanometers  $G_1$  and  $G_2$ , and a variable voltage source  $V$ . The correct circuit to carry out the experiment is

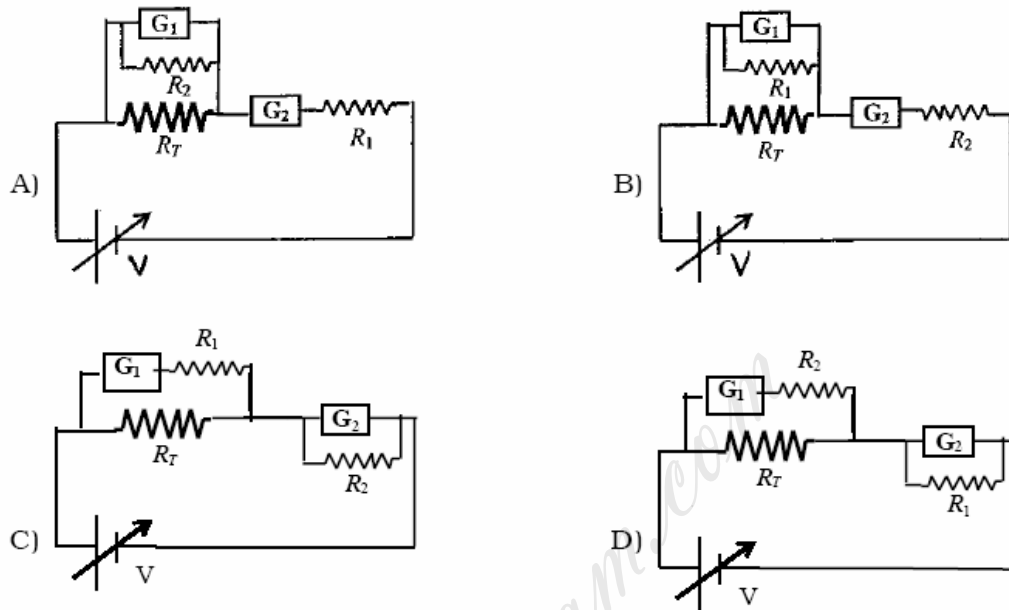

**ANSWER: C**

61. An AC voltage source of variable angular frequency  $\omega$  and fixed amplitude  $V_0$  is connected in series with a capacitance  $C$  and an electric bulb of resistance  $R$  (inductance zero). When  $\omega$  is increased
- A) the bulb glows dimmer
  - B) the bulb glows brighter
  - C) total impedance of the circuit is unchanged
  - D) total impedance of the circuit increases

**ANSWER: B**

62. A thin flexible wire of length  $L$  is connected to two adjacent fixed points and carries a current  $I$  in the clockwise direction, as shown in the figure. When the system is put in a uniform magnetic field of strength  $B$  going into the plane of the paper, the wire takes the shape of a circle. The tension in the wire is



- A)  $IBL$                       B)  $\frac{IBL}{\pi}$                       C)  $\frac{IBL}{2\pi}$                       D)  $\frac{IBL}{4\pi}$

**ANSWER: C**

63. A block of mass  $m$  is on an inclined plane of angle  $\theta$ . The coefficient of friction between the block and the plane is  $\mu$  and  $\tan\theta > \mu$ . The block is held stationary by applying a force  $P$  parallel to the plane. The direction of force pointing up the plane is taken to be positive. As  $P$  is varied from  $P_1 = mg(\sin\theta - \mu \cos\theta)$  to  $P_2 = mg(\sin\theta + \mu \cos\theta)$ , the frictional force  $f$  versus  $P$  graph will look like

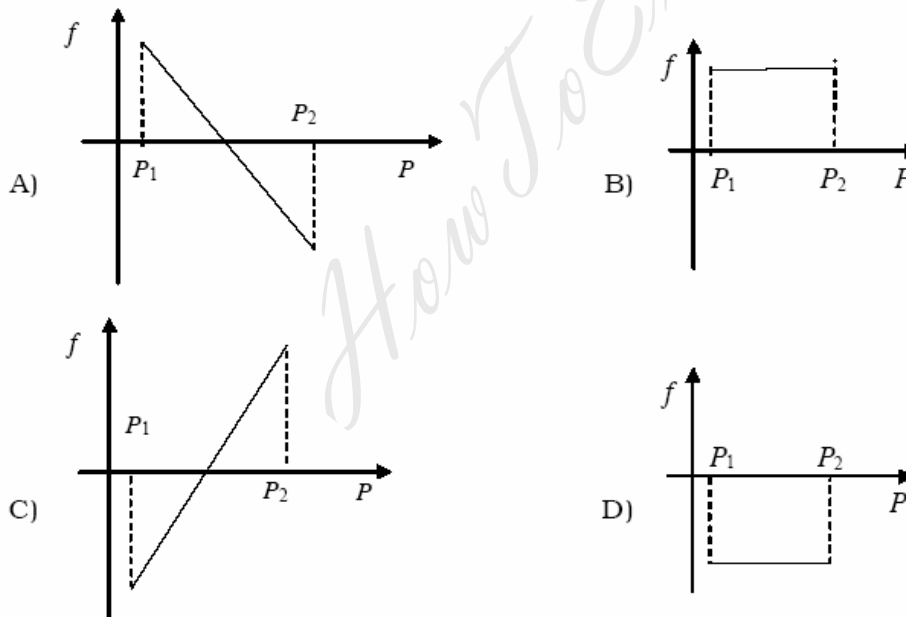
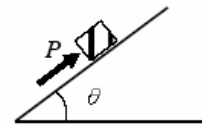

**ANSWER: A**

64. A thin uniform annular disc (see figure) of mass  $M$  has outer radius  $4R$  and inner radius  $3R$ . The work required to take a unit mass from point  $P$  on its axis to infinity is

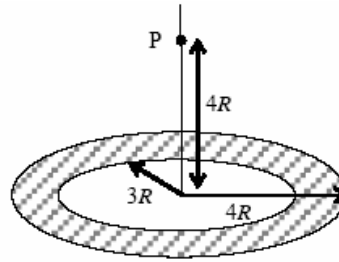

- A)  $\frac{2GM}{7R}(4\sqrt{2}-5)$       B)  $-\frac{2GM}{7R}(4\sqrt{2}-5)$       C)  $\frac{GM}{4R}$       D)  $\frac{2GM}{5R}(\sqrt{2}-1)$

**ANSWER: A**

**SECTION - II (Multiple Correct Choice Type)**

65. A few electric field lines for a system of two charges  $Q_1$  and  $Q_2$  fixed at two different points on the x-axis are shown in the figure. These lines suggest that

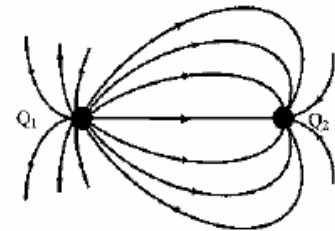

- A)  $|Q_1| > |Q_2|$   
 B)  $|Q_1| < |Q_2|$   
 C) at a finite distance to the left of  $Q_1$  the electric field is zero  
 D) at a finite distance to the right of  $Q_2$  the electric field is zero

**ANSWER: A and D**

66. A student uses a simple pendulum of exactly 1m length to determine  $g$ , the acceleration due to gravity. He uses a stop watch with the least count of 1 sec for this and records 40 seconds for 20 oscillations. For this observation, which of the following statement(s) is (are) true ?

- A) Error  $\Delta T$  in measuring  $T$ , the time period, is 0.05 seconds  
 B) Error  $\Delta T$  in measuring  $T$ , the time period, is 1 second  
 C) Percentage error in the determination of  $g$  is 5%  
 D) Percentage error in the determination of  $g$  is 2.5%

**ANSWER: A and C**

67. A point mass of 1 kg collides elastically with a stationary point mass of 5 kg. After their collision, the 1 kg mass reverses its direction and moves with a speed of  $2 \text{ ms}^{-1}$ . Which of the following statement(s) is (are) correct for the system of these two masses ?
- A) Total momentum of the system is  $3 \text{ kg ms}^{-1}$
  - B) Momentum of 5 kg mass after collision is  $4 \text{ kg ms}^{-1}$
  - C) Kinetic energy of the centre of mass is  $0.75 \text{ J}$
  - D) Total kinetic energy of the system is  $4 \text{ J}$

**ANSWER: A and C**

68. A ray OP of monochromatic light is incident on the face AB of prism ABCD near vertex B at an incident angle of  $60^\circ$  (see figure). If the refractive index of the material of the prism is  $\sqrt{3}$ , which of the following is (are) correct ?

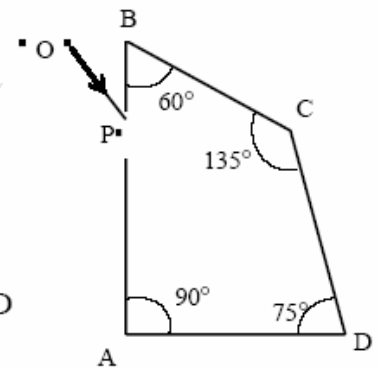

- A) The ray gets totally internally reflected at face CD
- B) The ray comes out through face AD
- C) The angle between the incident ray and the emergent ray is  $90^\circ$
- D) The angle between the incident ray and the emergent ray is  $120^\circ$

**ANSWER: A and B and C**

69. One mole of an ideal gas in initial state A undergoes a cyclic process ABCA, as shown in the figure. Its pressure at A is  $P_0$ . Choose the correct option(s) from the following

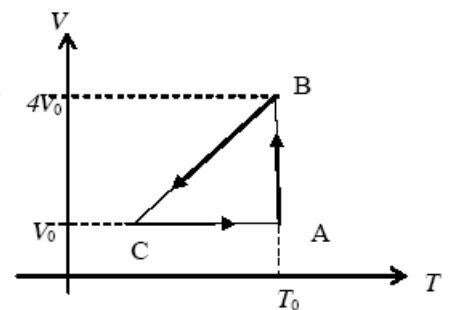

- A) Internal energies at A and B are the same
- B) Work done by the gas in process AB is  $P_0 V_0 \ln 4$
- C) Pressure at C is  $\frac{P_0}{4}$
- D) Temperature at C is  $\frac{T_0}{4}$

**ANSWER: A and B and C and D**

**SECTION – III (Paragraph Type)**

**Paragraph for Questions 70 to 72**

When a particle of mass  $m$  moves on the  $x$ -axis in a potential of the form  $V(x) = kx^2$ , it performs simple harmonic motion. The corresponding time period is proportional to  $\sqrt{\frac{m}{k}}$ , as can be seen easily using dimensional analysis. However, the motion of a particle can be periodic even when its potential energy increases on both sides of  $x = 0$  in a way different from  $kx^2$  and its total energy is such that the particle does not escape to infinity. Consider a particle of mass  $m$  moving on the  $x$ -axis. Its potential energy is  $V(x) = \alpha x^4$  ( $\alpha > 0$ ) for  $|x|$  near the origin and becomes a constant equal to  $V_0$  for  $|x| \geq X_0$  (see figure).

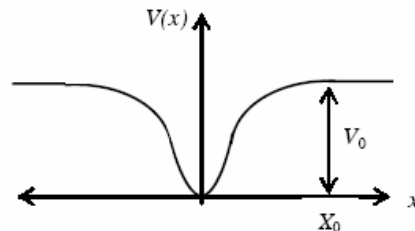

70. If the total energy of the particle is  $E$ , it will perform periodic motion only if  
 A)  $E < 0$                       B)  $E > 0$                       C)  $V_0 > E > 0$                       D)  $E > V_0$

**ANSWER: B or C or (B and C)**  
**Option C implies option B.**

71. For periodic motion of small amplitude  $A$ , the time period  $T$  of this particle is proportional to

- A)  $A\sqrt{\frac{m}{\alpha}}$                       B)  $\frac{1}{A}\sqrt{\frac{m}{\alpha}}$                       C)  $A\sqrt{\frac{\alpha}{m}}$                       D)  $\frac{1}{A}\sqrt{\frac{\alpha}{m}}$

**ANSWER: B**

72. The acceleration of this particle for  $|x| > X_0$  is

- B) proportional to  $\frac{V_0}{mX_0}$                       A) proportional to  $V_0$   
 C) proportional to  $\sqrt{\frac{V_0}{mX_0}}$                       D) zero

**ANSWER: D**

**Paragraph for Questions 73 to 74**

Electrical resistance of certain materials, known as superconductors, changes abruptly from a nonzero value to zero as their temperature is lowered below a critical temperature  $T_c(0)$ . An interesting property of superconductors is that their critical temperature becomes smaller than  $T_c(0)$  if they are placed in a magnetic field, i.e., the critical temperature  $T_c(B)$  is a function of the magnetic field strength  $B$ . The dependence of  $T_c(B)$  on  $B$  is shown in the figure.

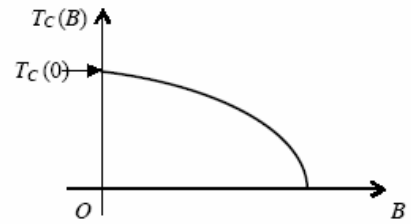

73. In the graphs below, the resistance  $R$  of a superconductor is shown as a function of its temperature  $T$  for two different magnetic fields  $B_1$  (solid line) and  $B_2$  (dashed line). If  $B_2$  is larger than  $B_1$ , which of the following graphs shows the correct variation of  $R$  with  $T$  in these fields ?

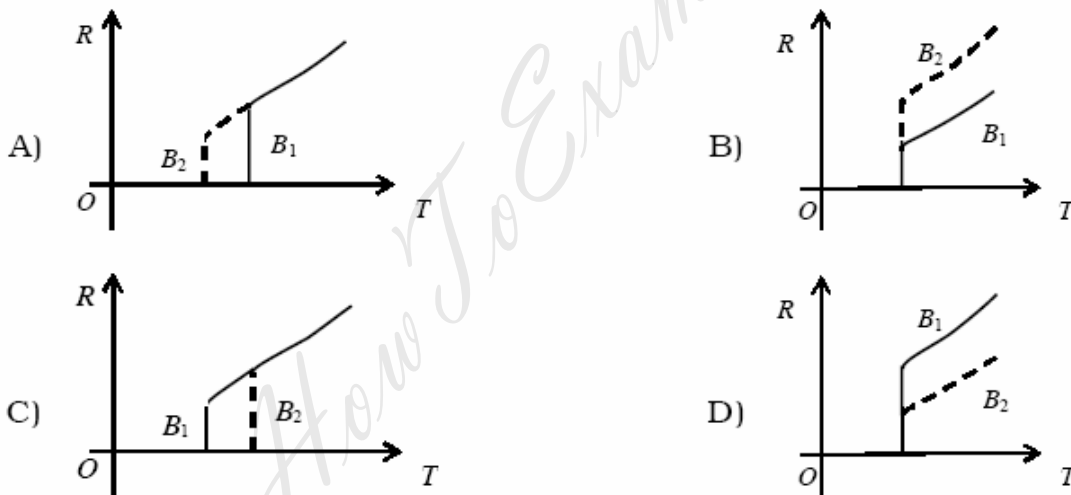

**ANSWER: A**

74. A superconductor has  $T_c(0) = 100$  K. When a magnetic field of 7.5 Tesla is applied, its  $T_c$  decreases to 75 K. For this material one can definitely say that when
- A)  $B = 5$  Tesla,  $T_c(B) = 80$  K
  - B)  $B = 5$  Tesla,  $75$  K  $<$   $T_c(B)$   $<$   $100$  K
  - C)  $B = 10$  Tesla,  $75$  K  $<$   $T_c(B)$   $<$   $100$  K
  - D)  $B = 10$  Tesla,  $T_c(B) = 70$  K

**ANSWER: B**

**SECTION – IV (Integer Type)**

75. The focal length of a thin biconvex lens is 20cm. When an object is moved from a distance of 25cm in front of it to 50cm, the magnification of its image changes from  $m_{25}$  to  $m_{50}$ . The ratio  $\frac{m_{25}}{m_{50}}$  is

**ANSWER: 6**

76. An  $\alpha$ -particle and a proton are accelerated from rest by a potential difference of 100V. After this, their de Broglie wavelengths are  $\lambda_\alpha$  and  $\lambda_p$  respectively. The ratio  $\frac{\lambda_p}{\lambda_\alpha}$ , to the nearest integer, is

**ANSWER: 3**

77. When two identical batteries of internal resistance  $1\Omega$  each are connected in series across a resistor R, the rate of heat produced in R is  $J_1$ . When the same batteries are connected in parallel across R, the rate is  $J_2$ . If  $J_1 = 2.25 J_2$  then the value of R in  $\Omega$  is

**ANSWER: 4**

78. Two spherical bodies A (radius 6 cm) and B (radius 18 cm) are at temperatures  $T_1$  and  $T_2$ , respectively. The maximum intensity in the emission spectrum of A is at 500 nm and in that of B is at 1500 nm. Considering them to be black bodies, what will be the ratio of the rate of total energy radiated by A to that of B ?

**ANSWER: 9**

79. When two progressive waves  $y_1 = 4 \sin(2x - 6t)$  and  $y_2 = 3 \sin\left(2x - 6t - \frac{\pi}{2}\right)$  are superimposed, the amplitude of the resultant wave is

**ANSWER: 5**

80. A 0.1 kg mass is suspended from a wire of negligible mass. The length of the wire is 1m and its cross-sectional area is  $4.9 \times 10^{-7} \text{m}^2$ . If the mass is pulled a little in the vertically downward direction and released, it performs simple harmonic motion of angular frequency  $140 \text{ rad s}^{-1}$ . If the Young's modulus of the material of the wire is  $n \times 10^9 \text{ Nm}^{-2}$ , the value of n is

**ANSWER: 4**

81. A binary star consists of two stars A (mass  $2.2M_{\odot}$ ) and B (mass  $11M_{\odot}$ ), where  $M_{\odot}$  is the mass of the sun. They are separated by distance  $d$  and are rotating about their centre of mass, which is stationary. The ratio of the total angular momentum of the binary star to the angular momentum of star B about the centre of mass is

**ANSWER: 6**

82. Gravitational acceleration on the surface of a planet is  $\frac{\sqrt{6}}{11}g$ , where  $g$  is the gravitational acceleration on the surface of the earth. The average mass density of the planet is  $\frac{2}{3}$  times that of the earth. If the escape speed on the surface of the earth is taken to be  $11 \text{ kms}^{-1}$ , the escape speed on the surface of the planet in  $\text{kms}^{-1}$  will be

**ANSWER: 3**

83. A piece of ice (heat capacity =  $2100 \text{ J kg}^{-1} \text{ }^{\circ}\text{C}^{-1}$  and latent heat =  $3.36 \times 10^5 \text{ J kg}^{-1}$ ) of mass  $m$  grams is at  $-5^{\circ}\text{C}$  at atmospheric pressure. It is given  $420 \text{ J}$  of heat so that the ice starts melting. Finally when the ice-water mixture is in equilibrium, it is found that  $1 \text{ gm}$  of ice has melted. Assuming there is no other heat exchange in the process, the value of  $m$  is

**ANSWER: 8**

84. A stationary source is emitting sound at a fixed frequency  $f_0$ , which is reflected by two cars approaching the source. The difference between the frequencies of sound reflected from the cars is  $1.2\%$  of  $f_0$ . What is the difference in the speeds of the cars (in km per hour) to the nearest integer ? The cars are moving at constant speeds much smaller than the speed of sound which is  $330 \text{ ms}^{-1}$ .

**ANSWER: 7**

\*\*\*\*\*